

reversible motor - series XV

XV-OM

HY TYPE MOTOR
 ø22 BODY-SHAPED FLANGE - MILLED SHANK

X 0 M 06 21 B B B E

Series	X	series XV
Group	0	group 0
Category	M	reversible motor
Displacement	06	0.76
Flange	21	Ø22 HY reversible rotation
Shaft	B	CF001 - Milled shank ø7 - thk.5
Body	IN	inlet - 1/4" GAS
	OUT	outlet - 1/4" GAS
Cover	E	reversible w/external drainage



XM017

Technical data table						
TYPE	Displacement cm3/rev	Max. Pressure		CODE		
		P1 bar	P3 bar	External drainage		Internal drainage
XV-OM/0.45	0,45	220	280	X 0 M 04 21 B B B E	X 0 M 04 21 B B B F	
XV-OM/0.57	0,56	220	280	X 0 M 05 21 B B B E	X 0 M 05 21 B B B F	
XV-OM/0.76	0,75	220	280	X 0 M 06 21 B B B E	X 0 M 06 21 B B B F	
XV-OM/0.98	0,92	220	280	X 0 M 07 21 B B B E	X 0 M 07 21 B B B F	
XV-OM/1.27	1,26	220	280	X 0 M 09 21 B B B E	X 0 M 09 21 B B B F	
XV-OM/1.52	1,48	220	280	X 0 M 11 21 B B B E	X 0 M 11 21 B B B F	
XV-OM/2.30	2,28	190	210	X 0 M 13 21 B B B E	X 0 M 13 21 B B B F	

P1) Max. working pressure - P3) Max. peak pressure

For heavy-duty applications, it is recommended to check the admissible torque of the shaft

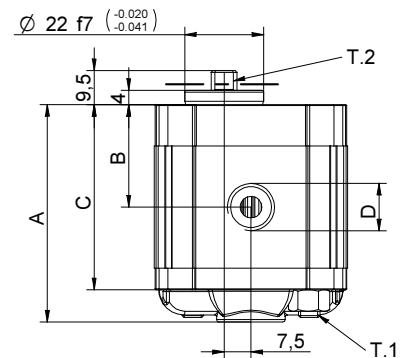
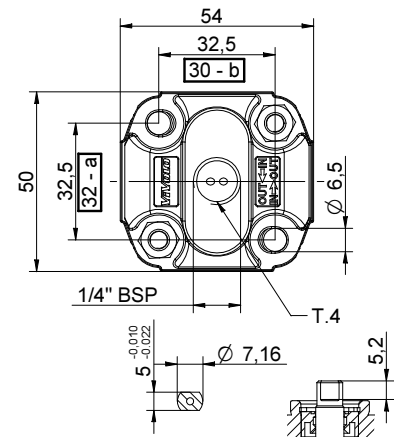

Dimensions table						
TYPE	Weight kg	A	B	C	D	D
		mm	mm	mm	IN	OUT
XV-OM/0.45	0,420	58,0	27,3	49,0	1/4" BSPP	1/4" BSPP
XV-OM/0.57	0,430	59,0	27,8	50,0	1/4" BSPP	1/4" BSPP
XV-OM/0.76	0,440	60,5	28,5	51,5	1/4" BSPP	1/4" BSPP
XV-OM/0.98	0,460	62,0	29,3	53,0	1/4" BSPP	1/4" BSPP
XV-OM/1.27	0,480	64,5	30,5	55,5	1/4" BSPP	1/4" BSPP
XV-OM/1.52	0,500	66,5	31,5	57,5	1/4" BSPP	1/4" BSPP
XV-OM/2.30	0,560	72,5	34,5	63,5	1/4" BSPP	1/4" BSPP

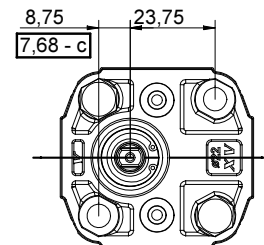

26/08/04 XOR0621888E.dft

T.1 = 11.7÷13.7 [Nm] - screw tightening torque M6



T.2 = 9.2 [Nm] - admissible shaft torque (N.B. When choosing a shaft, always check the admissible torque).

NOTE: This type of pump is also interchangeable with distance between centres of fastening in M5 (see dim. a, b, c).

Table of variations

XV-OM

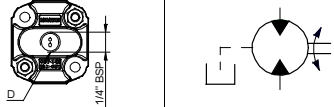
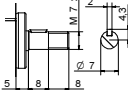
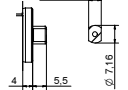
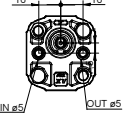
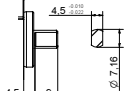
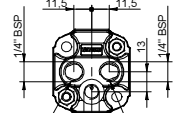
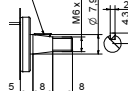
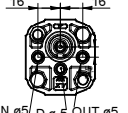
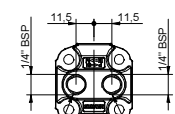
ø22 "HY" Body-Shaped FLANGE

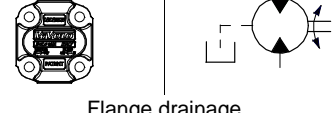
ø22 "HY" Body-Shaped FLANGE		Shaft		Cover				
	21	CI001 - Parallel T.2 = 2.1 [Nm]	A	CF001 - Milled shank T.2 = 9.2 [Nm]	B	 External drainage	E	
				 IN ø5 OUT ø5	24			CF005 - Milled shank T.2 = 8.4 [Nm]
	CO001 - Tapered T.2 = 21.9 [Nm]	E	 IN + OUT + external			K		
	 IN ø5 D ø5 OUT ø5	25					 IN + OUT + internal	L
			 Flange drainage	P				

Displacement	
TYPE	CODE
XV-OM/0.45	04
XV-OM/0.57	05
XV-OM/0.76	06
XV-OM/0.98	07
XV-OM/1.27	09
XV-OM/1.52	11
XV-OM/2.30	13

Standard bodies		
Displacement cm ³ /rev	Standard threads	
	0.17	B - B
0.25	B - B	Z - Z
0.45	B - B	Z - Z
0.57	B - B	Z - Z
0.76	B - B	Z - Z
0.98	B - B	Z - Z
1.27	B - B	Z - Z
1.52	B - B	Z - Z
2.30	B - B	Z - Z

Table showing standard flange and thread combinations available in stock

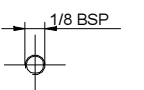
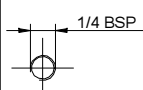
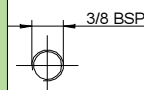
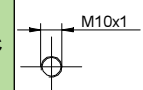
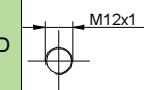
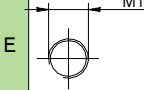
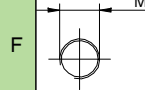
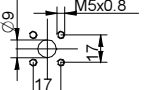
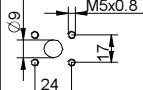
Body (threads/flanges)													
	A		B		C		D		E		F		G
	H		I	Closed Body		Z							